

SKSGT3054S

30-INCH GAS COOKTOP



POWER-UP OR SIMMER DOWN

Industry leading combined 67,500 BTUs includes a center Ultra-High burner delivering 24K BTUs of pure cooking power for great searing and quick stir frying and two Ultra-Low burners that simmer down to maintain temperatures as low as 140° to prepare delicate sauces and sugary confections.

BRASS BURNERS AND PORCELAIN COATED BURNER PAN

Five sealed brass burners and porcelain coated burner pan provides the ultimate in performance and easy clean-up. Brass burners provide luxury styling while spillovers wipe away easily without the concern of scratching the top and keeps the cooking surface looking new.

GLASS TOUCH LED KITCHEN TIMER AND KNOB LIGHTING

Never worry about overcooking the food with a built-in timer right on the cooktop. Backlit knob lighting indicates which knob is on at a glance, providing an extra level of safety.

HEAVY-DUTY GRATES WITH BUILT-IN CONVERTIBLE WOK GRATE

Heavy-duty cast iron grates allow for easy pot movement across all burners. The center burner easily converts for round bottom wok cooking, allowing for preparing stir-fry with professional- style results at home.

WI-FI ENABLED FOR CONNECTIVITY

Connect the cooktop to the hood for automatic communication with each other so the burners and fans are synchronized. Utilize the ThinQ® app for burner monitoring and push notifications, ensuring your cooktop is operating perfectly.

Innovation

Wi-Fi Enabled for ThinQ® Control with iPhone / Android App	Yes
Remote Monitoring	Yes

Cooktop Features

Cooktop Surface	Black Stainless Steel / Black Porcelain
Number of Burners / Elements	5
Sealed Gas Burners (Brass)	Yes
Continuous Grates	3
Dishwasher Safe Grates	Yes
Cooktop Control Knobs with LED Back Lighting	Yes , Metal
Display with Kitchen Timer	Yes

Cooktop Performance

Burner Power BTU/h (NG / LP)	
Left Rear	10,000 / 10,000
Right Rear	10,000 / 10,000
Center	24,000 / 16,000
Left Front	10,000 / 10,000
Right Front	13,500 / 10,000
Simmer Burner Power BTU/h (NG)	
Left Rear	1,300
Right Rear	1,300
Center (Warming Zone)	650
Left Front	1,300
Right Front	1,300

Technical Specs

Energy Source Gas	Natural Gas
Alternative Energy Source LP Gas	LP Gas
LP Conversion Kit Included	Yes
Required Power Supply	120VAC, 60Hz

©2025 LG Electronics USA, Inc. All rights reserved. "Signature Kitchen Suite" and the Signature Kitchen Suite logo are registered trademarks of LG Electronics Inc. Design, features and specifications are subject to change without notice. Specifications are for planning purposes only. Consult the product's installation instructions for final dimensional data and other details prior to making cutouts or custom panels. Consult with a heating and ventilation engineer for your specific ventilation requirements. Non-metric weights and measurements are approximate. Smart features require Internet access.

1-855-790-6655 | www.signaturekitchensuite.com

SKSGT3054S 30-INCH GAS COOKTOP

Dimensions and Weight

Overall Width	30" (760 mm)
Height of Cooktop Base	3 3/4" (95 mm)
Overall Depth	21" (533 mm)
Net Weight (approx.)	69 lbs.
Shipping Weight (approx.)	77 lbs.

Accessories

Included Accessories	Wok Convertible Grate (Center)
----------------------	--------------------------------------

Warranty Summary*

Limited Warranty, Parts & Labor	3 Years
---------------------------------	---------

COOKTOP DIMENSIONS

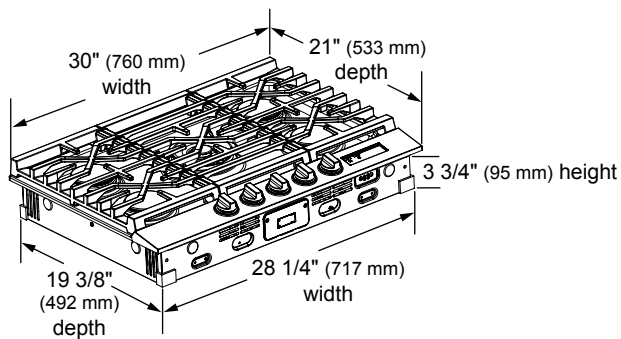

*These warranties give you specific legal rights and you may have other rights that vary from state to state. For complete warranty details, refer to your Use & Care manual.

CUTOUT DIMENSIONS AND CLEARANCES

Provide enough clearances between the cooktop and adjacent combustible surfaces. These dimensions must be met for safe use of your cooktop. The location of the Electrical outlet and pipe opening may be adjusted to meet specific requirements. The cooktop may be placed with 2 3/4" clearance to the back wall.

MAINTAIN THE FOLLOWING MINIMUM CLEARANCE DIMENSIONS

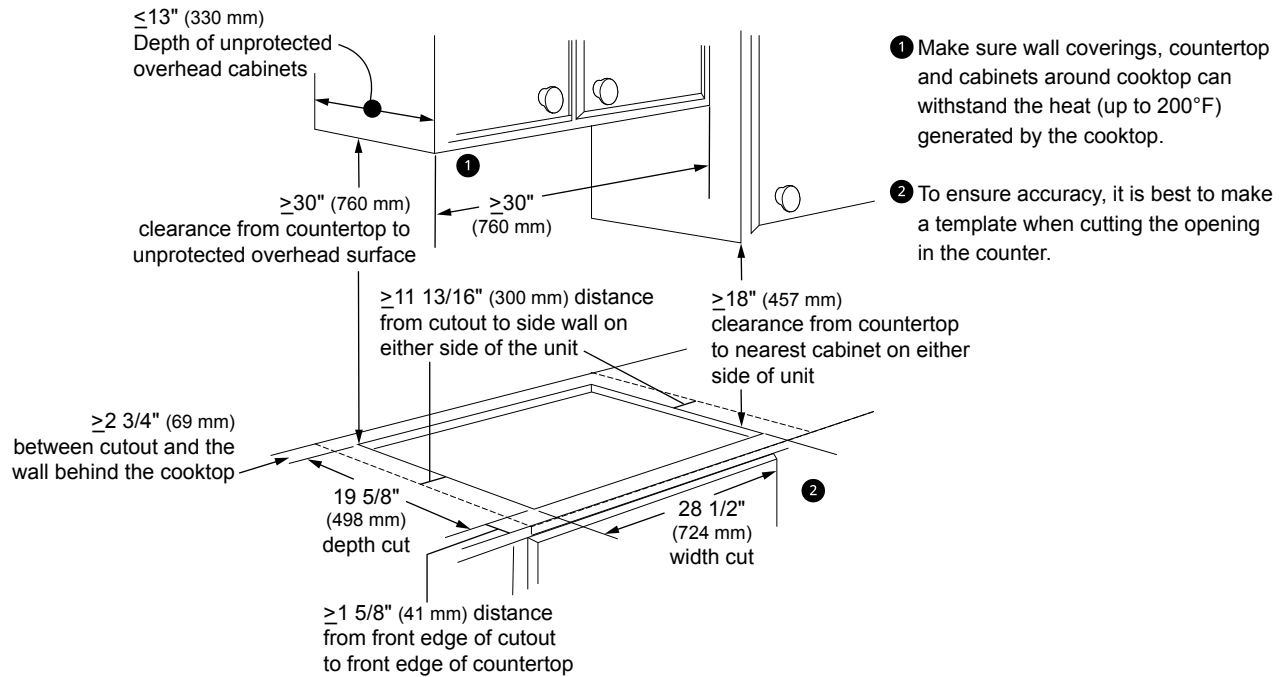

CUTOUT DIMENSIONS – INSTALLED ABOVE SIGNATURE KITCHEN SUITE SINGLE WALL OVEN

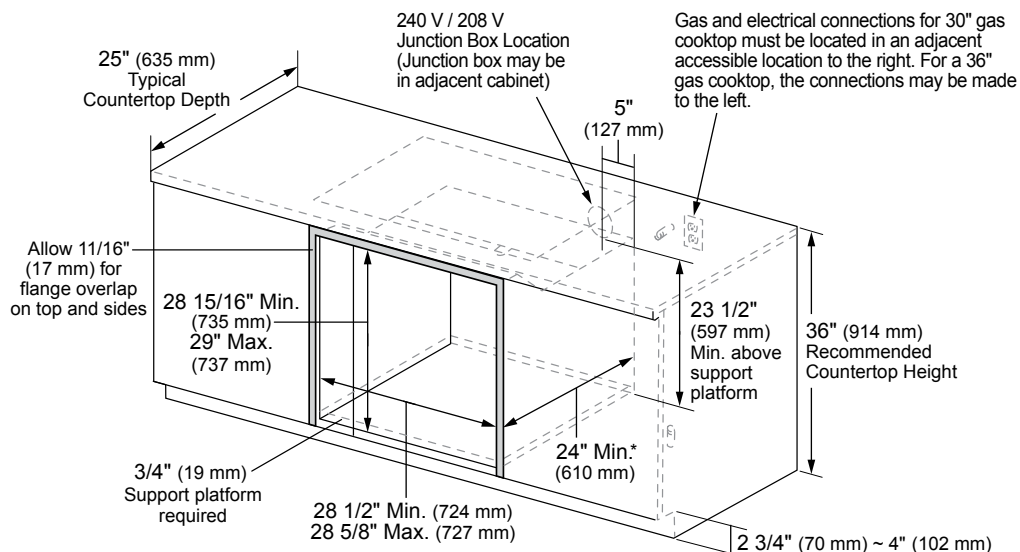

*25" Min. (635 mm) cutout depth required for undercounter flush installation. Refer to installation art for flush installation in wall cabinet for required cutout dimensions.